



POOL BREAKDOWN

ROYAL RETREAT ~ PS 15' ROUND 52'' RESIN TOP RAIL - RESIN VERTICAL

√	QTY	CARTON NUMBER	CARTON DESCRIPTION
	1	5-9915-834	ASSEMBLY PACK CARTON
	1	5-9810-726	TOP RAIL PACK CARTON
	1	5-9710-604	VERTICAL PACK CARTON
	1	5-0568-015	SIDEWALL CARTON
	1	5-9999-410	TOP CONNECTOR CARTON
	1	5-9110-834	SKIRT PACK CARTON



CARTON BREAKDOWN

✓	ITEM	QTY	PART NUMBER	DESCRIPTION
ASSEMBLY PACK # 5-9915-834				
	1	8	583-1070	Stabilizer Rail (Large)
	2	8	583-1071	Stabilizer Rail (Small)
	3	10	580-2407	Bottom connector
	4	10	580-2408	Vertical end cap
	5	26	545-1001	Plastic coping
	6	10	589-1302P	Bottom rail
	11	100	330-1127	Sheet metal screw, #10 x 1/2"
	12	10	580-2397	Vertical tab
	13	10	330-1075	Pan head screw #14 x 1/2"
	—	1	573-5781	Pool Parts List
	—	1	573-4047	Installation Instructions
	—	1	— — —	Warranty Card
	—	1	573-3169	"Safety First" Booklet

TOP RAIL PACK # 5-9810-726				
	14	10	587-1741	Top Rail

VERTICAL PACK # 5-9710-604				
	15	10	341-1351	Vertical

TOP CONNECTOR PACK # 5-9999-410				
	16	10	340-2802	Top Connector

SKIRT PACK # 5-9110-834				
	17	10	340-2801	Skirt
	18	10	510-1001	#10 x 1-1/2" Slotted Pan head screw

SIDEWALL CARTON # 5-0568-015				
	29	1	5-0568-015	Sidewall
	30	1	535-1442	Protective Strip
	31	26	321-1029	1/4-20 Hex Flange Locknut
	32	26	330-1280	1/4-20 x 1/2" Grade 5 Bolt
	—	1	560-1055	Warning Sign
	—	1	573-3169	"Safety First" Booklet
	—	1	573-3498	Safety DVD

EXPLODED PARTS VIEW

REMOVE PRIOR TO INSTALLATION
ONLY USE ON SIDE SUPPORTS FOR
OVAL POOLS

REMOVE PRIOR TO
INSTALLATION.
USE PLUG TO COVER
SCREW HOLE AFTER
INSTALLATION.

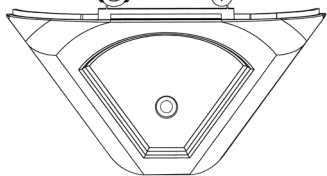

FRONT VIEW - SKIRT

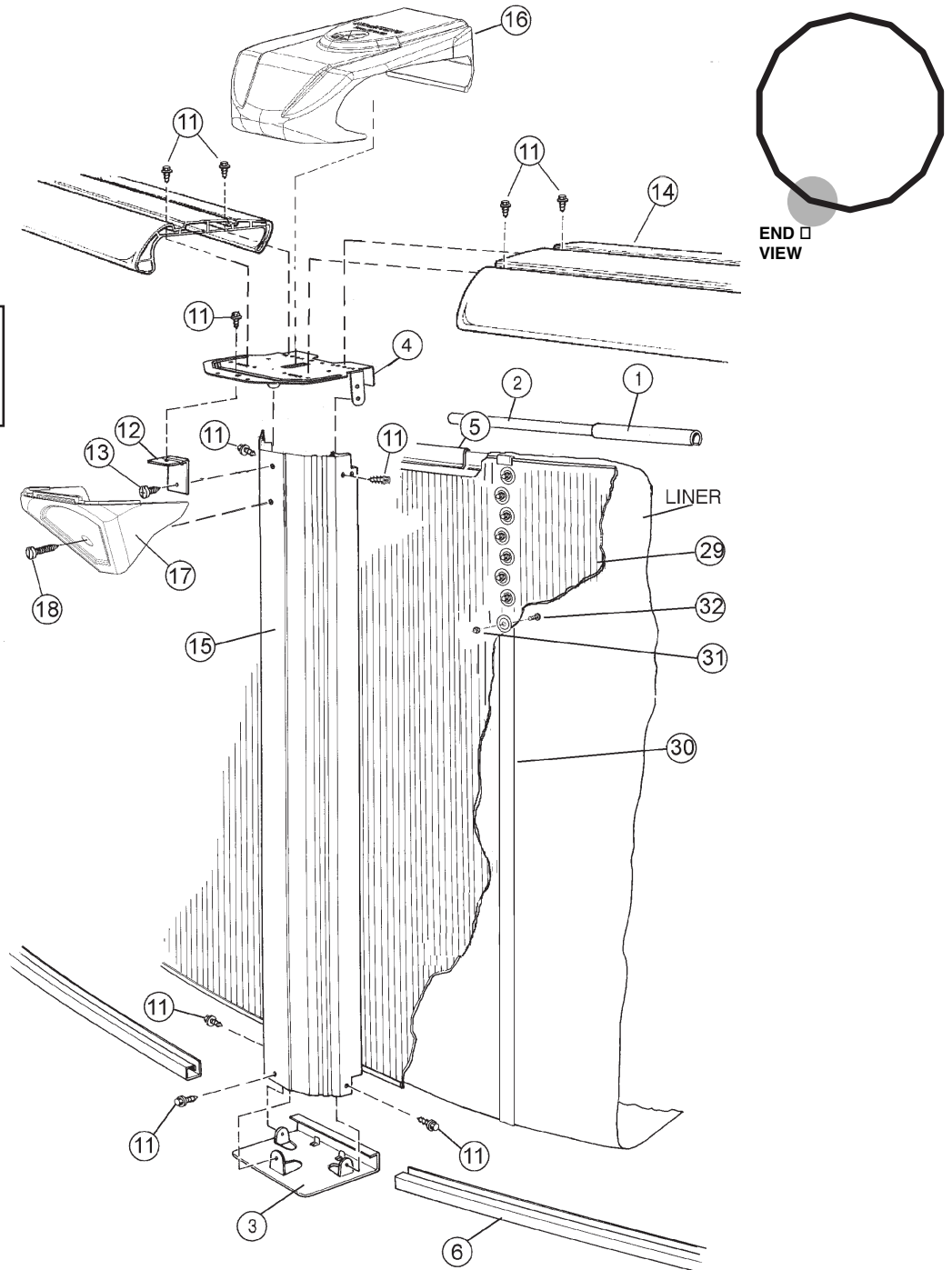

Important! Above-ground pools are designed for swimming and wading only. Do not Dive or Jump! Misuse of your pool may result in crippling injury and/or other dangers to life and health. Do not use slides, diving boards, or any other platform or object which can be used for improper pool entry. Use only an above-ground swimming pool ladder or entry system to enter or exit your pool. Never attempt to swim or reach behind ladders or any other pool entry system. It is the pool owner's responsibility to secure the pool against unauthorized, unsupervised or unintentional entry. It is also the pool owner's responsibility to warn all pool users of the hazards of diving into shallow water: paralyzing injury may result. Always obey all safety rules. Remember, pool safety is everybody's responsibility.

Safety decals and caution information provided with your pool have been endorsed by the U.S. Consumer Product Safety Commission. It is mandatory that the pool owner and installer follow the installation and use directions for all provided safety signs and decals. Juveniles must be supervised at all times by a responsible adult as directed by the USCPSC.

Change of Design: The manufacturer (Hill) expressly reserves the right to change or modify the design and construction of any product in due course of their manufacturing procedures, without incurring any obligation to furnish or install such changes or modifications on products previously or subsequently sold.